

ProMedia Cabinets



*Mix Drawer Heights
30" and 48" Widths
Contemporary Styling
Discrete Slot Data Media Racks
Overfile available for the 48" Cabinet*

Classic Media Cabinets



*Classic Styling for Match-in
Dedicated Microfilm Cabinets
3 Footprints - More Size Options
Discrete Slot Audio-Video Racks
"AA" Size 3" Drawer for Small Media*

Visuflex Media Storage



*Rollfilm Carousels
Multi-Media Laterals
Dedicated Cabinets for Microfilm
Budget Alternative for Popular Media
Stackable Cabinets for Smaller Collections*

ProMedia
Cabinets

Classic &
VF
Cabinets

Media Shelving
& Slidetrac

Axess &
MaxRac

Media
Gentrac

Slimecase
& Slidetrac

File
Gentrac

Tambour
Door Kits

Introduction

What are they...

ProMedia cabinets are the result of years of engineering refinement designed specifically to address the unique needs of storing small media

Why would I use these....

ProMedia cabinets are great for smaller media and for mixed collections where you need different size drawers in the same cabinet. ProMedia Cabinets also allow the addition of the CO-7 Overfile, providing additional storage in the same footprint.

Unique Features:

Cabinets:

- **All 24" Deep** - Ergonomic reach
- **3 Cabinet Heights** - Short, Medium & Tall
- **2 Cabinet Widths** - 30" & 48"
- **Heavy Gauge Welded Construction**
- **Powder Coat Finish** - Durability with no offgassing
- **Leveling Glides** - Standard
- **Optional Turn Key Locks** - Easy security
- **Overfile** - Add on to any 48" wide cabinet

Drawers:

- **Full Width Pulls** - Clean contemporary styling
- **Mix Drawer Sizes** - Accommodates Multi-Media
- **Slide-N-Lock Divider** - Provides infinite adjustability
- **Optional Media Racks** - Great for Data Media applications
- **Heavy Duty Ball Bearing Slides** - Smooth Quiet Drawer Operation
- **Drawer Interlocks** - Standard for Safety

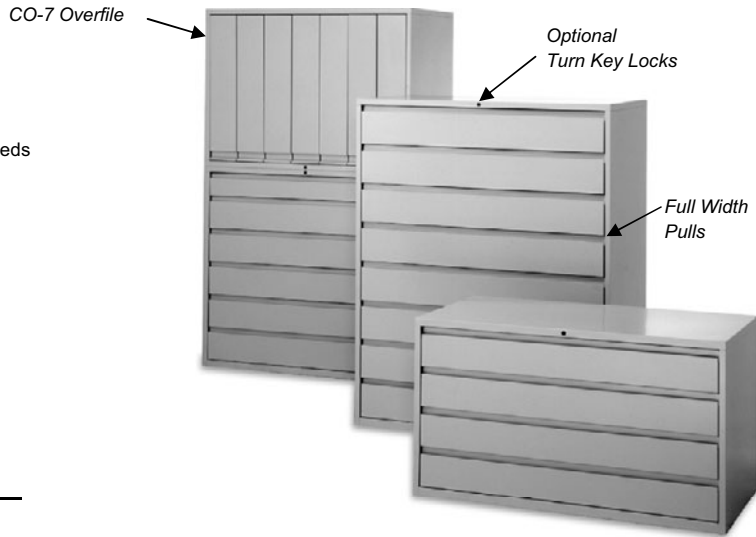

Part Number Logic:

CM48 - 6 - 8

- Dividers** - Qty. per Drawer
- Drawer** - Nominal Drawer Height
- Width** - O.D. Cabinet Width
- Height** - Case Height S = Short, M = Med, T = Tall
- Product Type** - "C" = ProMedia Cabinet

The ProMedia Drawer System

Select between drop-in **Media Racks** or **Slide-N-Lock Dividers** with **Bookend** supports

Drop-in Wire Media Rack
Provides discrete slot filing for Data Media applications

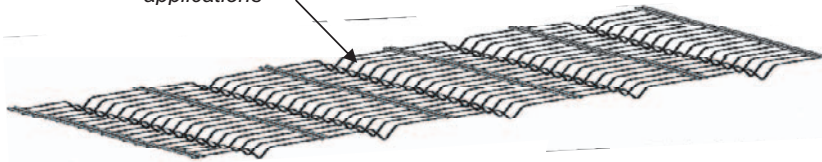

Wire Media Racks
available for:
4mm
8mm
3480 /3490
DLT in case or no case
LTO
CD or DVD in Jewelcase

Slide-N-Lock Divider
Provides infinite adjustment for maximum capacity

Lift to release spring tension

Bookend
Supports each row

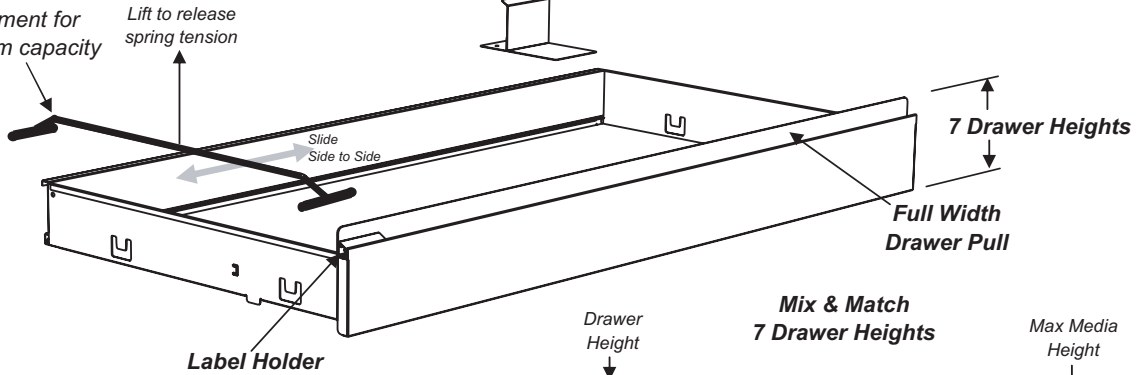

Inside Drawer Dimensions

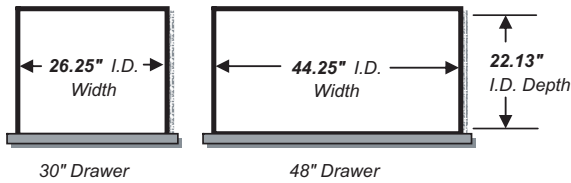

Mix & Match 7 Drawer Heights

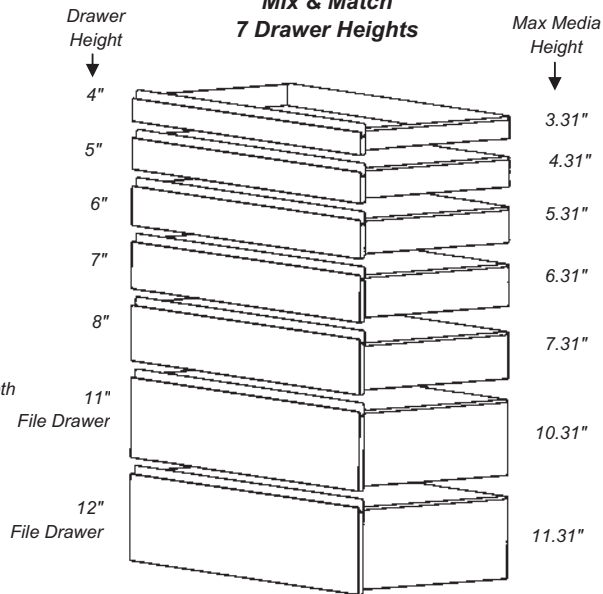

The ProMedia Cabinet System
Easy as One, Two, Three!

One Depth

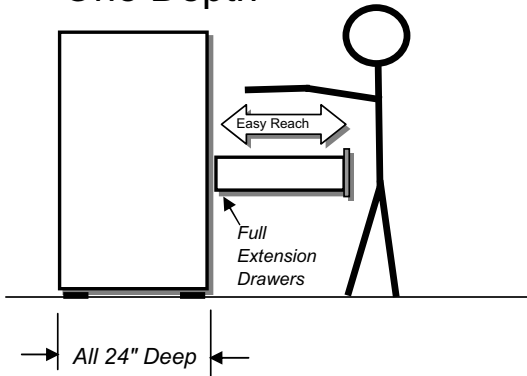

We thought about this...a lot

All ProMedia cabinets are 24" deep because this was the optimum depth, providing maximum capacity within easy reach.

When we studied the popular media formats we found that the combination of 30" and 48" wide cabinets fit the media the best compared to say, 36" or 42".

We offer 3 heights to accommodate desk side applications, counter height applications and the maximum height that still allows the user to access the top drawer.

Two Widths

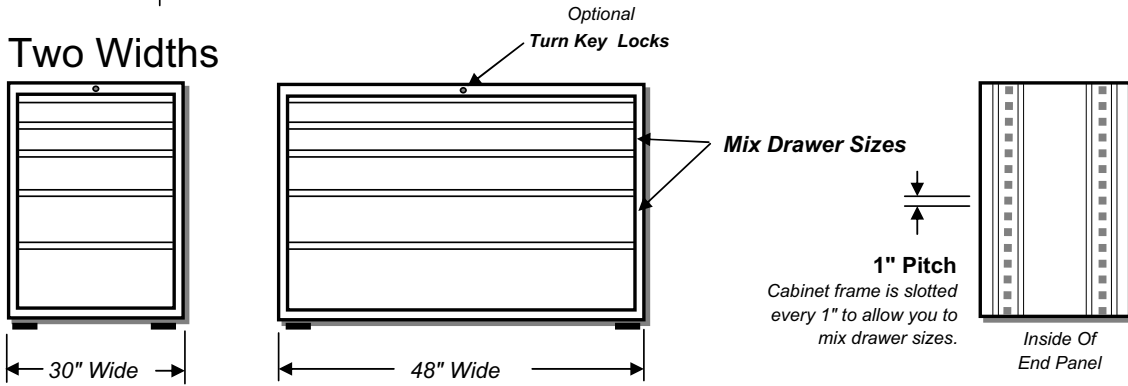

Three Heights

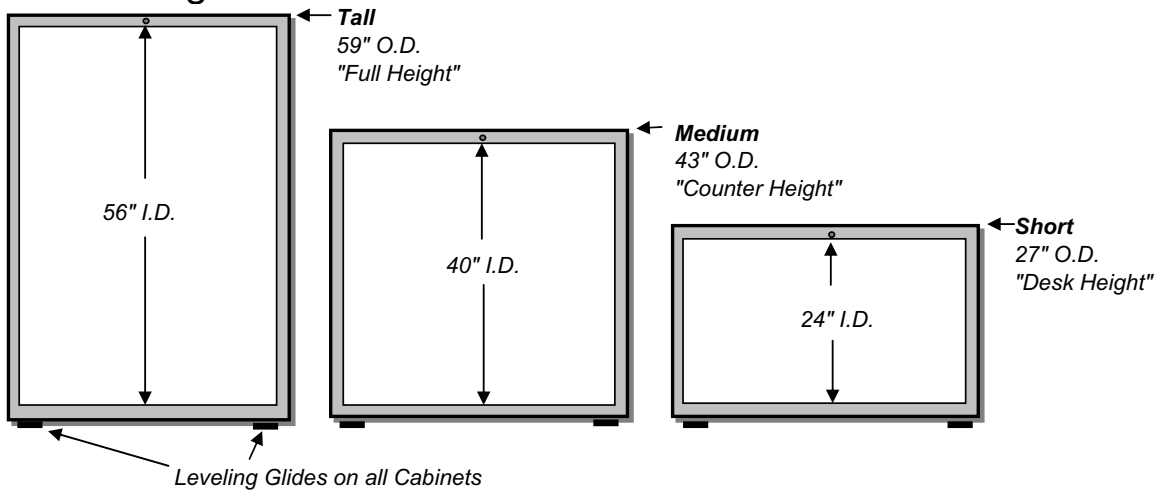

ProMedia Cabinets

Classic & VF Cabinets

Media Shelving & Slidetrac

Access & MaxRac

Media Gemtrac

Slimcase & Slidetrac

File Gemtrac

Tambour Door Kits

"How do I decide which cabinet to use?"

1 Consider Drawer Sizes:



Choose from 5 Drawer Heights
See previous page for details

2 Consider Cabinet Footprints:

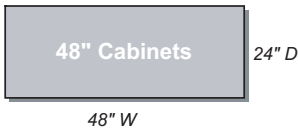
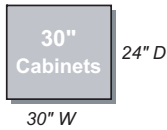

3 Consider Drawer Count:

Dwr:	Short	Med	Tall
"4"	6	10	14
"5"	4	8	11
"6"	4	6	9
"7"	3	5	8
"8"	3	5	7

4 Make sure your media fits - in the selected drawer

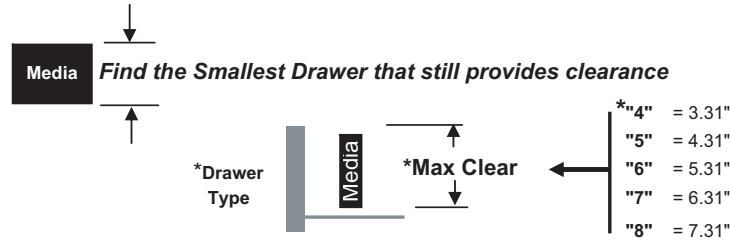

*See Next Page for Drawer Heights and Media Sizes

5 Calculate Quantity Per Row

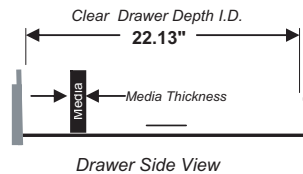

Divide: $\frac{22.13 \text{ Drawer Depth I.D.}}{\text{Media Thickness}} = \text{QTY Per Row}$

6 Calculate Number of Rows

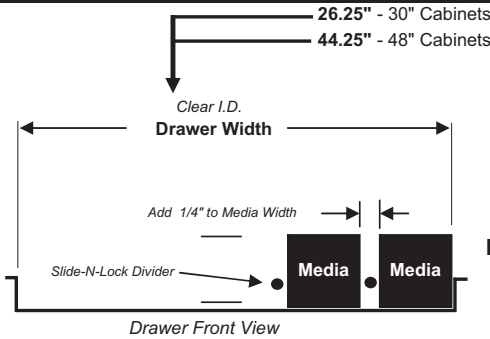

Divide: $\frac{\text{Drawer Width I.D.}}{\text{Media Width} + 1/4"} = \text{Number of Rows}$

6 Calculate Final Capacity

$\text{QTY Per Row} \times \text{*No. of Rows} = \text{Capacity Per Dwr} \times \text{No. of Dwr} = \text{Capacity Per Cab}$

*Number of Dividers needed per drawer is one less than the number of rows.
Order Dividers and / or Media Racks as separate line items.

ProMedia Cabinets

Classic & VF Cabinets

Media Shelving & Slidetrac

Axess & MaxRac

Media Genetrac

Slidetrac & Slidetrac

File Genetrac

Tambour Door Kits

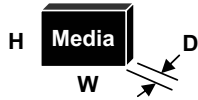

CAPACITY RANGE

Media	H	W	D	Rack Avail?	CAPACITY RANGE			
					30" / Dwr	48" / Dwr	Short 30"	Tall 48"
<i>Capacities with Dividers - Less with Racks</i>								
4" Drawer								
Mini DV	1.90	2.60	0.50	-	396	660	2,376	9,240
Magstar	2.31	5.38	0.63	-	140	245	840	3,430
4mm	2.42	3.17	0.63	YES	245	455	1,470	6,370
				Capacity w/ Rack	180	330	1,080	4,620
8mm	2.76	4.06	0.84	YES	156	260	936	3,640
				Capacity w/ Rack	115	207	690	2,898
Audio Csst.	2.75	4.31	0.69	-	160	288	960	4,032
Small DVC-Pro	2.75	4.13	0.81	-	162	270	972	3,780
Large DVC-Pro	3.25	5.19	0.81	-	108	216	648	3,024
Small DV-Cam	3.06	4.25	0.75	-	145	261	870	3,654

Drawers: S=6, M=10, T=14 See Page 9 & 10

5" Drawer								
Large DV-Cam	3.75	5.44	0.81	-	108	189	432	2,079
VHS Sleeve	4.11	7.52	1.13	-	57	95	228	1,045
DLT, No Case	4.13	4.13	1.00	YES	132	220	528	2,420
				Capacity w/ Rack	95	175	380	1,925

Drawers: S=4, M=8, T=11 See Page 11 & 12

6" Drawer								
LTO	4.31	4.53	1.09	YES	100	180	400	1,620
				Capacity w/ Rack	90	144	360	1,296
DLT w/ Box	4.40	4.44	1.25	YES	85	153	340	1,377
				Capacity w/ Rack	75	120	300	1,080
3480 Type	4.25	4.88	1.00	YES	110	198	440	1,782
				Capacity w/ Rack	95	175	380	1,925
Small Beta	4.44	6.82	1.25	-	51	102	204	918
VHS - Case	4.69	8.00	1.19	-	54	90	216	810
Small D2	5.13	7.75	1.60	-	39	65	156	585

Drawers: S=4, M=6, T=9 See Page 13 & 14

7" Drawer								
CD / DVD Jewelcase	5.63	4.91	0.41	YES	265	424	795	3,392
				Capacity w/ Rack	164	328	492	2,624
DVD Album	5.63	7.50	0.63	-	105	175	315	1,400
5.25 MO Sleeve	5.44	6.06	0.50	-	176	308	528	2,464

Drawers: S=3, M=5, T=8 See Page 15 & 16

8" Drawer								
Large Beta	6.44	10.69	1.25	-	34	68	102	476
3/4 Umatic	6.88	10.00	1.52	-	28	70	84	490
D2 Large	6.94	11.25	1.60	-	26	39	78	273

Drawers: S=3, M=5, T=7 See Page 17 & 18

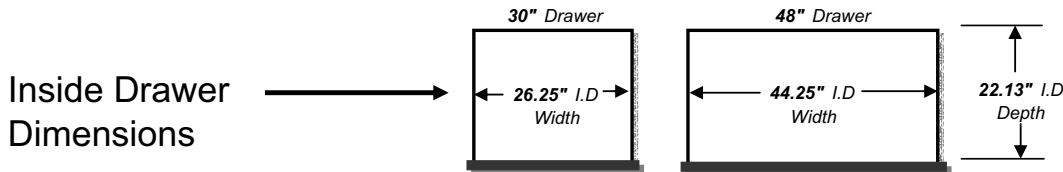

Notes: 1. The capacities published here are considered reliable but not guaranteed. Media sizes do vary, check dimensions to be sure.

ProMedia Cabinets
 Classic & VF Cabinets
 Media Shelving & Slidetrac
 Axes & MaxRac
 Media Gemtrac
 Slimcase & Slidetrac
 File Gemtrac
 Tambour Door Kits

Empty Drawers - See also Preconfigured Cabinets on the next page

For Any Media under 3 5/16" tall



Model	Description	4" Dwr	Divider / Dwr	Bonus Dwr	Height	Width	Depth	Weight	*Ship	List
CS30-4X	Short, 30w- 4" Dwrs	6	-	-	26 3/4	30	24	200	\$75	\$1,714
CS48-4X	Short, 48w- 4" Dwrs	6	-	-	26 3/4	48	24	290	\$100	\$2,034
CM30-4X	Med, 30w - 4" Dwrs	10	-	-	42 3/4	30	24	310	\$100	\$2,352
CM48-4X	Med, 48w - 4" Dwrs	10	-	-	42 3/4	48	24	455	\$125	\$2,839
CT30-4X	Tall, 30w - 4" Dwrs	14	-	-	58 3/4	30	24	420	\$125	\$2,996
CT48-4X	Tall, 48w - 4" Dwrs	14	-	-	58 3/4	48	24	605	\$150	\$3,650
-L	Optional Turn Key Lock							5		\$73
SLD-22	Slide-N-Lock Drawer Divider				2	3/16	22	0.3	UPS	\$3
BE-2X2	2" Bookend				2 1/2	1 3/4	2 1/4	0.2	UPS	\$8
BE-3X3	3" Bookend				2 3/4	2 3/4	2 1/4	0.2	UPS	\$8

Capacity Calculations:

1. Make sure your media fits - in this drawer size

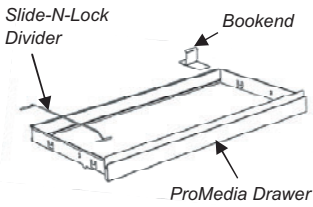

2. Calculate Quantity Per Row

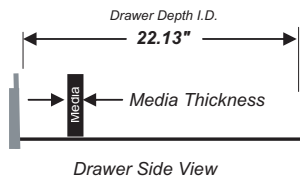
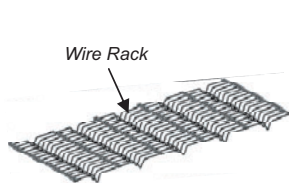

Divide: $\frac{22.13'' \text{ Drawer Depth I.D.}}{\text{Media Thickness}} = \text{QTY Per Row}$

For **Data Media** applications, See All Wire Media Rack Options on page 22.

3. Calculate Number of Rows

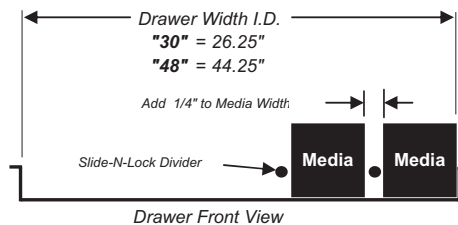

Divide: $\frac{\text{Drawer Width I.D.}}{\text{Media Width} + 1/4''} = \text{Number of Rows}$

4. Calculate Final Capacity

$\text{QTY Per Row} \times \text{*No. of Rows} = \text{Capacity Per Dwr} \times \text{No. of Dwrs} = \text{Capacity Per Cab}$

*Number of Dividers needed per drawer is one less than the number of rows. Order Dividers and / or Media Racks as separate line items.

*UPS at Actual \$
*Flat Rate \$175 MIN

Preconfigured for:

Small Cassettes - Under 3 5/16"H



Model	Description	4" Dwr	Divider / Dwr	Bonus Dwr	Height	Width	Depth	Weight	*Ship	List
CS30-4-6	Short, 30w- 4" Dwr	6	6	-	26 3/4	30	24	205	\$75	\$1,835
CS48-4-12	Short, 48w- 4" Dwr	6	12	-	26 3/4	48	24	310	\$100	\$2,276
CM30-4-6	Med, 30w - 4" Dwr	10	6	-	42 3/4	30	24	325	\$100	\$2,554
CM48-4-12	Med, 48w - 4" Dwr	10	12	-	42 3/4	48	24	485	\$125	\$3,242
CT30-4-6	Tall, 30w - 4" Dwr	14	6	-	58 3/4	30	24	440	\$125	\$3,278
CT48-4-12	Tall, 48w - 4" Dwr	14	12	-	58 3/4	48	24	650	\$150	\$4,215
-L	Optional Turn Key Lock							5		\$73

Drawers Only - Configured as above with dividers

Drawer Inside Clear

D30-4-6	4" H x 30 Drawer Only - w/ 6 Dividers	3.31	26.25	22.125	30	Incl	\$177
D48-4-12	4" H x 48 Drawer Only - w/ 12 Dividers	3.31	44.25	22.125	41	Incl	\$237
SLD-22	Slide-N-Lock Drawer Divider	2	3/16	22	0.3	UPS	\$3
BE-2X2	2" Bookend	2 1/2	1 3/4	2 1/4	0.2	UPS	\$8
BE-3X3	3" Bookend	2 3/4	2 3/4	2 1/4	0.2	UPS	\$8

Capacities with Dividers - Dividers included with above part numbers

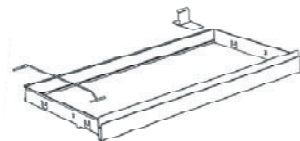

Drawer with Dividers

	30" Cabinet Capacity					48" Cabinet Capacity			
	Per Row	/ Dwr	Short	Med	Tall	/ Dwr	Short	Med	Tall
Mini DV*	44	396	2,376	3,960	5,544	660	3,960	6,600	9,240
Magstar	35	140	840	1,400	1,960	245	1,470	2,450	3,430
4mm	35	245	1,470	2,450	3,430	455	2,730	4,550	6,370
8mm	26	156	936	1,560	2,184	260	1,560	2,600	3,640
Audio Cassette	32	160	960	1,600	2,240	288	1,728	2,880	4,032
Small DVC Pro	27	162	972	1,620	2,268	270	1,620	2,700	3,780
Large DVC Pro	27	108	648	1,080	1,512	216	1,296	2,160	3,024
Small DV Cam	29	145	870	1,450	2,030	261	1,566	2,610	3,654

*Mini DV requires 2 additional dividers per drawer, both 30" & 48"

Capacities with Media Racks - Order Cabinet Separately without Dividers and Racks



Wire Media Rack

Rack Number	Media	30" Cabinet Capacity				48" Cabinet Capacity				UPS	List
		/ Dwr	Short	Med	Tall	/ Dwr	Short	Med	Tall		
DR30-4mm	4mm	180	1,080	1,800	2,520	-	-	-	-	UPS	\$45
DR48-4mm	4mm					330	1,980	3,300	4,620	UPS	\$90
	Slot Size: .63 x 3.20										
DR30-8mm	8mm	115	690	1,150	1,610					UPS	\$45
DR48-8mm	8mm	-	-	-	-	207	1,242	2,070	2,898	UPS	\$90
	Slot Size: .85 x 4.18										

For Data Media applications, See All Wire Media Rack Options on page 22.

*UPS at Actual \$

*Flat Rate \$175 MIN

Notes: 1. The capacities published here are considered reliable but not guaranteed. Media sizes do vary, check dimensions to be sure.

Empty Drawers - See also Preconfigured Cabinets on the next page

For Any Media under 4 5/16" tall



Model	Description	5" Dwrs	Divider / Dwr	Bonus Dwr	Height	Width	Depth	Weight	*Ship	List
CS30-5X	Short, 30w- 5" Dwrs	4	-	4"	26 3/4	30	24	180	\$75	\$1,579
CS48-5X	Short, 48w- 5" Dwrs	4	-	4"	26 3/4	48	24	260	\$100	\$1,868
CM30-5X	Med, 30w - 5" Dwrs	8	-	-	42 3/4	30	24	270	\$100	\$2,083
CM48-5X	Med, 48w - 5" Dwrs	8	-	-	42 3/4	48	24	395	\$125	\$2,508
CT30-5X	Tall, 30w - 5" Dwrs	11	-	1" Filler	58 3/4	30	24	360	\$125	\$2,621
CT48-5X	Tall, 48w - 5" Dwrs	11	-	1" Filler	58 3/4	48	24	520	\$150	\$3,190
-L	Optional Turn Key Lock							5		\$73
SLD-22	Slide-N-Lock Drawer Divider				2	3/16	22	0.3	UPS	\$3
BE-4X4	4" Bookend				3 3/4	3 3/4	2 1/4	0.3	UPS	\$8

Capacity Calculations:

1. Make sure your media fits - in this drawer size

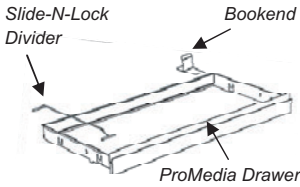

2. Calculate Quantity Per Row

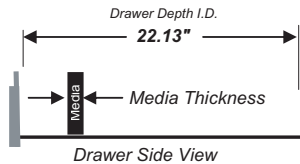
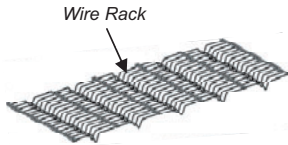

Divide: $\frac{22.13"}{22.13"} = \text{QTY Per Row}$
 By: $\frac{\text{Media Thickness}}{\text{Media Thickness}}$

3. Calculate Number of Rows

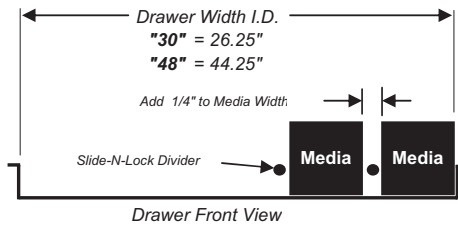

Divide: $\frac{\text{Drawer Width I.D.}}{\text{Media Width} + 1/4"} = \text{Number of Rows}$
 By: $\frac{\text{Media Width} + 1/4"}{\text{Media Width} + 1/4"}$

4. Calculate Final Capacity

$\text{QTY Per Row} \times \text{*No. of Rows} = \text{Capacity Per Dwr} \times \text{No. of Dwrs} = \text{Capacity Per Cab}$

*Number of Dividers needed per drawer is one less than the number of rows.
 Order Dividers and / or Media Racks as separate line items.

For **Data Media** applications, See All Wire Media Rack Options on page 22.

*UPS at Actual \$
 *Flat Rate \$175 MIN

Preconfigured for:

Small Cassettes - Under 4 5/16"H



Model	Description	5" Dwr	5" Divider / Dwr	Bonus Dwr	Height	Width	Depth	Weight	*Ship	List
CS30-5-4	Short, 30w- 5" Dwrs	4	4	4"	26 3/4	30	24	182	\$75	\$1,633
CS48-5-8	Short, 48w- 5" Dwrs	4	8	4"	26 3/4	48	24	270	\$100	\$1,976
CM30-5-4	Med, 30w - 5" Dwrs	8	4	-	42 3/4	30	24	275	\$100	\$2,191
CM48-5-8	Med, 48w - 5" Dwrs	8	8	-	42 3/4	48	24	405	\$125	\$2,723
CT30-5-4	Tall, 30w - 5" Dwrs	11	4	1" Filler	58 3/4	30	24	370	\$125	\$2,769
CT48-5-8	Tall, 48w - 5" Dwrs	11	8	1" Filler	58 3/4	48	24	535	\$150	\$3,485
-L	Optional Turn Key Lock							5		\$73

No dividers in bonus drawer and not included in capacity calculation.

Drawers Only - Configured as above with dividers Drawer Inside Clear

D30-5-4	5" H x 30 Drawer Only - w/ 4 Dividers	4.31	26.25	22.125	30					\$176
D48-5-8	5" H x 48 Drawer Only - w/ 8 Dividers	4.31	44.25	22.125	39					\$232
SLD-22	Slide-N-Lock Drawer Divider	2	3/16	22	0.3				UPS	\$3
BE-4X4	4" Bookend	3 3/4	3 3/4	2 1/4	0.3				UPS	\$8

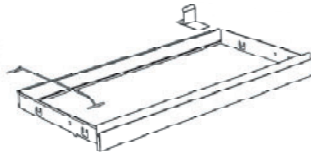

Drawer with Dividers

Capacities with Dividers - Dividers included with above part numbers

	Per Row	30" Cabinet Capacity				48" Cabinet Capacity			
		/ Dwr	Short	Med	Tall	/ Dwr	Short	Med	Tall
Large DV Cam	27	108	432	864	1,188	189	756	1,512	2,079
VHS Sleeve	19	57	228	456	627	95	380	760	1,045
DLT - No Case	22	132	528	1,056	1,452	220	880	1,760	2,420

Capacities with Media Racks - Order Cabinet Separately without Dividers and Racks



Wire Media Rack

Rack Number	Media	30" Cabinet Capacity				48" Cabinet Capacity				*Ship	List
		/ Dwr	Short	Med	Tall	/ Dwr	Short	Med	Tall		
DR30-3480	DLT No Case	95	380	760	1,045	-	-	-	-	UPS	\$45
DR48-3480	DLT No Case					175	700	1,400	1,925	UPS	\$90

Slot Size: 1.01 x 4.32

For **Data Media** applications,
See All Wire Media Rack Options
on page 22.

*UPS at Actual \$
*Flat Rate \$175 MIN

Notes: 1. The capacities published here are considered reliable but not guaranteed. Media sizes do vary, check dimensions to be sure.

Empty Drawers - See also Preconfigured Cabinets on the next page

For Any Media under 5 5/16" tall



Model	Description	6" Dwrs	Divider / Dwr	Bonus Dwr	Height	Width	Depth	Weight	*Ship	List
CS30-6X	Short, 30w- 6" Dwrs	4	4	-	26 3/4	30	24	155	\$75	\$1,449
CS48-6X	Short, 48w- 6" Dwrs	4	8	-	26 3/4	48	24	230	\$100	\$1,698
CM30-6X	Med, 30w - 6" Dwrs	6	4	4"	42 3/4	30	24	245	\$100	\$1,956
CM48-6X	Med, 48w - 6" Dwrs	6	8	4"	42 3/4	48	24	360	\$125	\$2,335
CT30-6X	Tall, 30w - 6" Dwrs	9	4	2" Filler	58 3/4	30	24	320	\$125	\$2,356
CT48-6X	Tall, 48w - 6" Dwrs	9	8	2" Filler	58 3/4	48	24	460	\$150	\$2,840
-L	Optional Turn Key Lock							5		\$73
SLD-22	Slide-N-Lock Drawer Divider				2	3/16	22	0.3	UPS	\$3
BE-5X5	5" Bookend				4 3/4	4 3/4	2 1/4	0.6	UPS	\$8

Capacity Calculations:

1. Make sure your media fits - in this drawer size

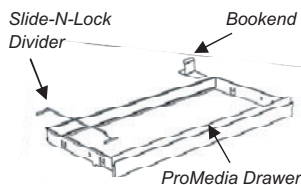

Media Store Any Media Up To 5 5/16" Tall (5.31")

2. Calculate Quantity Per Row

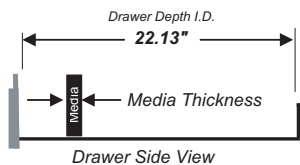
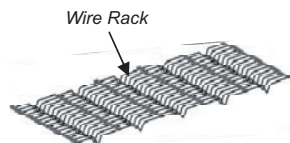

Divide: $\frac{22.13"}{22.13"} = \text{QTY Per Row}$
 By: $\frac{\text{Media Thickness}}$

For Data Media applications, See All Wire Media Rack Options on page 22.

3. Calculate Number of Rows

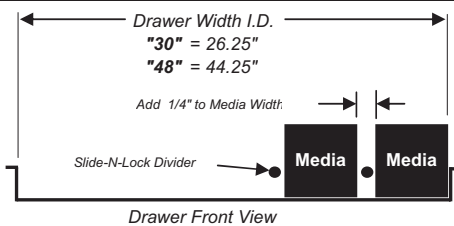

Divide: $\frac{\text{Drawer Width I.D.}}{\text{Media Width} + 1/4"} = \text{Number of Rows}$
 By:

4. Calculate Final Capacity

$\text{QTY Per Row} \times \text{*No. of Rows} = \text{Capacity Per Dwr} \times \text{No. of Dwrs} = \text{Capacity Per Cab}$

*Number of Dividers needed per drawer is one less than the number of rows. Order Dividers and / or Media Racks as separate line items.

*UPS at Actual \$
 *Flat Rate \$175 MIN

Preconfigured for:

Tape Cassettes - Under 5 5/16"H

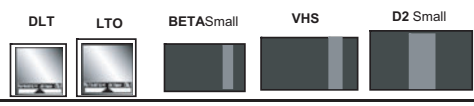

Model	Description	6" Dwr	6" Divider / Dwr	Bonus Dwr	Height	Width	Depth	Weight	*Ship	List
CS30-6-4	Short, 30w- 6" Dwrs	4	4	-	26 3/4	30	24	160	\$75	\$1,503
CS48-6-8	Short, 48w- 6" Dwrs	4	8	-	26 3/4	48	24	240	\$100	\$1,805
CM30-6-4	Med, 30w - 6" Dwrs	6	4	4"	42 3/4	30	24	255	\$100	\$2,036
CM48-6-8	Med, 48w - 6" Dwrs	6	8	4"	42 3/4	48	24	370	\$125	\$2,496
CT30-6-4	Tall, 30w - 6" Dwrs	9	4	2" Filler	58 3/4	30	24	330	\$125	\$2,477
CT48-6-8	Tall, 48w - 6" Dwrs	9	8	2" Filler	58 3/4	48	24	475	\$150	\$3,082
-L	Optional Turn Key Lock							5		\$73

No dividers in bonus drawer and not included in capacity calculation.

Drawers Only - Configured as above with dividers *Drawer Inside Clear*

D30-6-4	6" H x 30 Drawer Only - w/ 4 Dividers	5.31	26.25	22.125	31	\$183
D48-6-8	6" H x 48 Drawer Only - w/ 8 Dividers	5.31	44.25	22.125	41	\$239
SLD-22	Slide-N-Lock Drawer Divider	2	3/16	22	0.3	\$3
BE-5X5	5" Bookend	4 3/4	4 3/4	2 1/4	0.6	\$8

Capacities with Dividers - Dividers included with above part numbers

	30" Cabinet Capacity					48" Cabinet Capacity			
	Per Row	/ Dwr	Short	Med	Tall	/ Dwr	Short	Med	Tall
DLT	17	85	340	510	765	153	612	918	1,377
LTO	20	100	400	600	900	180	720	1080	1,620
3480 / 3490	22	110	440	660	990	198	792	1,188	1,782
Small Beta	17	51	204	306	459	102	408	612	918
VHS Case	18	54	216	324	486	90	360	540	810
Small D2	13	39	156	234	351	65	260	390	585

Capacities with Media Racks - Order Cabinet Separately without Dividers and Racks

Rack Number	Media	30" Cabinet Capacity				48" Cabinet Capacity				UPS	List
		/ Dwr	Short	Med	Tall	/ Dwr	Short	Med	Tall		
DR30-DLT	DLT	75	300	450	675	-	-	-	-	UPS	\$45
DR48-DLT	DLT	-	-	-	-	120	480	720	1,080	UPS	\$90
Slot Size: 1.28 x 4.50											
DR30-LTO	LTO	90	360	540	810	-	-	-	-	UPS	\$45
DR48-LTO	LTO	-	-	-	-	144	576	864	1,296	UPS	\$90
Slot Size: 1.17 x 4.56											
DR30-3480	3480 / 3490	95	380	760	1,045	-	-	-	-	UPS	\$45
DR48-3480	3480 / 3490	-	-	-	-	175	700	1,400	1,925	UPS	\$90
Slot Size: 1.01 x 4.32											

For Data Media applications,
See All Wire Media Rack Options
on page 22.

*UPS at Actual \$
*Flat Rate \$175 MIN

Notes: 1. The capacities published here are considered reliable but not guaranteed. Media sizes do vary, check dimensions to be sure.

ProMedia Cabinets
 Classic & VF Cabinets
 Media Shelving & Slidetrac
 Axess & MaxRac
 Media Gemtrac
 Slimcase & Slidetrac
 File Gemtrac
 Tambour Door Kits

Empty Drawers - See also Preconfigured Cabinets on the previous page

For Any Media under 6 5/16" tall



Hinged "Bookend"

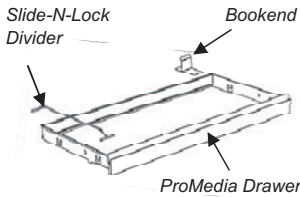

ProMedia Drawer

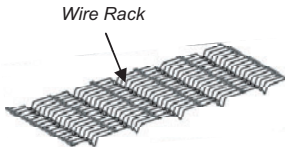

Wire Rack

For **Data Media** applications,
See All Wire Media Rack Options
on page 22.

Model	Description	7" Dwrs	Divider / Dwr	Bonus Dwr	Height	Width	Depth	Weight	*Ship	List
CS30-7X	Short, 30w- 7" Dwrs	3	-	3" Filler	26 3/4	30	24	140	\$75	\$1,337
CS48-7X	Short, 48w- 7" Dwrs	3	-	3" Filler	26 3/4	48	24	190	\$100	\$1,551
CM30-7X	Med, 30w- 7" Dwrs	5	-	5"	42 3/4	30	24	225	\$100	\$1,831
CM48-7X	Med, 48w- 7" Dwrs	5	-	5"	42 3/4	48	24	305	\$125	\$2,165
CT30-7X	Tall, 30w- 7" Dwrs	8	-		58 3/4	30	24	315	\$125	\$2,216
CT48-7X	Tall, 48w- 7" Dwrs	8	-		58 3/4	48	24	420	\$150	\$2,638
-L	Optional Turn Key Lock							5		\$73
SLD-22	Slide-N-Lock Drawer Divider				2	3/16	22	0.3	UPS	\$3
BE-6X6	6" Bookend				5 3/4	5 3/4	2 1/4	0.7	UPS	\$8
BE-CD	Hinged Bookend for CD's				3 3/4	4	2 1/4	1	UPS	\$11

Capacity Calculations:

1. Make sure your media fits - in this drawer size



2. Calculate Quantity Per Row

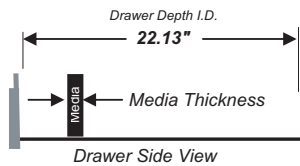

Divide: $\frac{22.13'' \text{ Drawer Depth I.D.}}{\text{Media Thickness}} = \text{QTY Per Row}$

3. Calculate Number of Rows

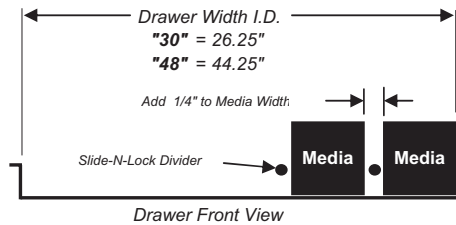

Divide: $\frac{\text{Drawer Width I.D.}}{\text{Media Width} + 1/4''} = \text{Number of Rows}$

4. Calculate Final Capacity

$\text{QTY Per Row} \times \text{*No. of Rows} = \text{Capacity Per Dwr} \times \text{No. of Dwrs} = \text{Capacity Per Cab}$

*Number of Dividers needed per drawer is one less than the number of rows.
Order Dividers and / or Media Racks as separate line items.

*UPS at Actual \$
*Flat Rate \$175 MIN

Preconfigured for:

Tape & Discs - Under 6 5/16"H



Model	Description	7" Dwr	Divider / Dwr	Bonus Dwr	Height	Width	Depth	Weight	*Ship	List
CS30-7-4	Short, 30w- 7" Dwr	3	4	3" Filler	26 3/4	30	24	145	\$75	\$1,378
CS48-7-8	Short, 48w- 7" Dwr	3	8	3" Filler	26 3/4	48	24	200	\$100	\$1,632
CM30-7-4	Med, 30w - 7" Dwr	5	4	5"	42 3/4	30	24	230	\$100	\$1,898
CM48-7-8	Med, 48w - 7" Dwr	5	8	5"	42 3/4	48	24	315	\$125	\$2,299
CT30-7-4	Tall, 30w - 7" Dwr	8	4	-	58 3/4	30	24	325	\$125	\$2,324
CT48-7-8	Tall, 48w - 7" Dwr	8	8	-	58 3/4	48	24	435	\$150	\$2,853
-L	Optional Turn Key Lock							5		\$73

No dividers in bonus drawer and not included in capacity calculation.

Drawers Only - Configured as above with dividers

Drawer Inside Clear

D30-7-4	7" H x 30 Drawer Only - w/ 4 Dividers	6.31	26.25	22.125	31					\$190
D48-7-8	7" H x 48 Drawer Only - w/ 8 Dividers	6.31	44.25	22.125	41					\$245
SLD-22	Slide-N-Lock Drawer Divider	2	3/16	22	0.3				UPS	\$3
BE-6X6	6" Bookend	5 3/4	5 3/4	2 1/4	0.7				UPS	\$8
BE-CD	Hinged Bookend for CD's	3 3/4	4	2 1/4	1				UPS	\$11



Hinged "Bookend"

Capacities with Dividers - Dividers included with above part numbers

	30" Cabinet Capacity					48" Cabinet Capacity			
	Per Row	/ Dwr	Short	Med	Tall	/ Dwr	Short	Med	Tall
CD / DVD Jewellcase	53	265	795	1,325	2,120	424	1,272	2,120	3,392
DVD Album	35	105	315	525	840	175	525	875	1,400
5.25 MO Sleeve	41	176	528	880	1,408	308	924	1,540	2,464

5.25 MO in the case vary by brand. Contact customer service with your exact dimensions if you need assistance calculating capacities.

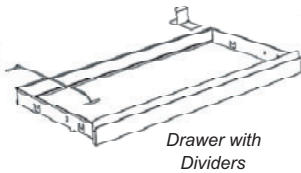

Drawer with Dividers

Capacities with Media Racks - Order Cabinet Separately without Dividers and Racks

Rack Number	Media	30" Cabinet Capacity				48" Cabinet Capacity					List
		/ Dwr	Short	Med	Tall	/ Dwr	Short	Med	Tall		
DR30-CD	*CD / DVD	164	492	820	1,312	-	-	-	-	UPS	\$45
DR48-CD	*CD / DVD	-	-	-	-	328	984	1,640	2,624	UPS	\$90
	*Jewellcase										
	Slot Size:	.42 x 4.95									

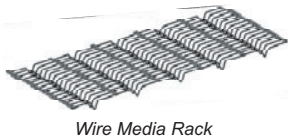

Wire Media Rack

For Data Media applications, See All Wire Media Rack Options on page 22.

*UPS at Actual \$
*Flat Rate \$175 MIN

Notes: 1. The capacities published here are considered reliable but not guaranteed. Media sizes do vary, check dimensions to be sure.

Empty Drawers - See also Preconfigured Cabinets on the previous page

For Any Media under 7 5/16" tall



Model	Description	8" Dwrs	Divider / Dwr	Bonus Dwr	Height	Width	Depth	Weight	*Ship	List
CS30-8X	Short, 30w- 8" Dwrs	3	-	-	26 3/4	30	24	135	\$75	\$1,324
CS48-8X	Short, 48w- 8" Dwrs	3	-	-	26 3/4	48	24	190	\$100	\$1,530
CM30-8X	Med, 30w - 8" Dwrs	5	-	-	42 3/4	30	24	205	\$100	\$1,702
CM48-8X	Med, 48w - 8" Dwrs	5	-	-	42 3/4	48	24	285	\$125	\$1,999
CT30-8X	Tall, 30w - 8" Dwrs	7	-	-	58 3/4	30	24	290	\$125	\$2,087
CT48-8X	Tall, 48w - 8" Dwrs	7	-	-	58 3/4	48	24	400	\$150	\$2,474
-L	Optional Turn Key Lock							5		\$73
SLD-22	Slide-N-Lock Drawer Divider				2	3/16	22	0.3	UPS	\$3
BE-6X6	6" Bookend				5 3/4	5 3/4	2 1/4	0.7	UPS	\$8



Hinged "Bookend"

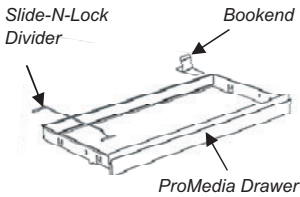

Capacity Calculations:

1. Make sure your media fits - in this drawer size



2. Calculate Quantity Per Row

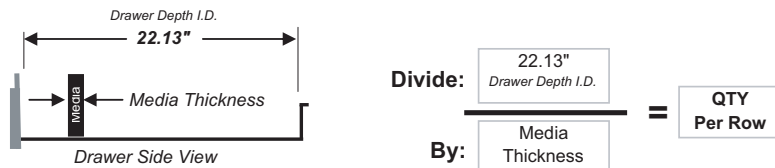

3. Calculate Number of Rows

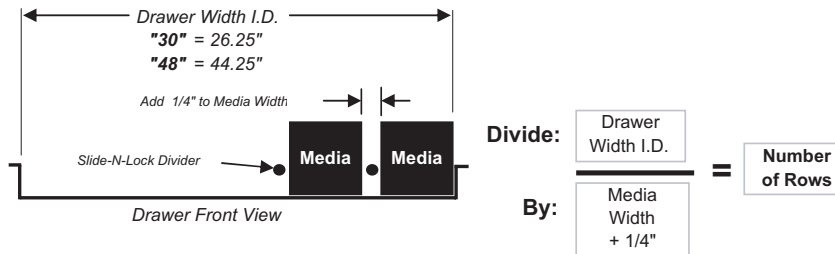

4. Calculate Final Capacity

$$\text{QTY Per Row} \times \text{*No. of Rows} = \text{Capacity Per Dwr} \times \text{No. of Dwrs} = \text{Capacity Per Cab}$$

*Number of Dividers needed per drawer is one less than the number of rows. Order Dividers and / or Media Racks as separate line items.

*UPS at Actual \$
*Flat Rate \$175 MIN

Preconfigured for:

Large Tape - Under 7 5/16"H

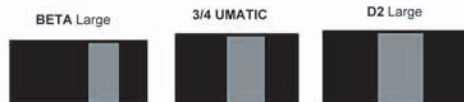

Model	Description	8" Dwr	Divider / Dwr	Bonus Dwr	Height	Width	Depth	Weight	*Ship	List
CS30-8-1	Short, 30w - 8" Dwrs	3	1	-	26 3/4	30	24	135	\$75	\$1,334
CS48-8-2	Short, 48w - 8" Dwrs	3	2	-	26 3/4	48	24	190	\$100	\$1,550
CM30-8-1	Med, 30w - 8" Dwrs	5	1	-	42 3/4	30	24	210	\$100	\$1,719
CM48-8-2	Med, 48w - 8" Dwrs	5	2	-	42 3/4	48	24	290	\$125	\$2,033
CT30-8-1	Tall, 30w - 8" Dwrs	7	1	-	58 3/4	30	24	295	\$125	\$2,110
CT48-8-2	Tall, 48w - 8" Dwrs	7	2	-	58 3/4	48	24	405	\$150	\$2,521
-L	Optional Turn Key Lock							5		\$65

Drawers Only - Configured as above with dividers

Drawer Inside Clear

D30-8-1	8" H x 30 Drawer Only - w/ 1 Dividers	7.31	26.25	22.125	31		\$233
D48-8-2	8" H x 48 Drawer Only - w/ 2 Dividers	7.31	44.25	22.125	41		\$187
SLD-22	Slide-N-Lock Drawer Divider	2	3/16	22	0.3	UPS	\$3
BE-6X6	6" Bookend	5 3/4	5 3/4	2 1/4	0.7	UPS	\$8

Capacities with Dividers - Dividers included with above part numbers

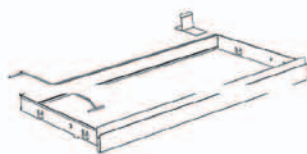

Drawer with Dividers

	30" Cabinet Capacity					48" Cabinet Capacity			
	/ Dwr	/ Dwr	Short	Med	Tall	/ Dwr	Short	Med	Tall
Beta - Large	17	34	102	170	238	68	204	340	476
3/4 Umatic	14	28	84	140	196	70	210	350	490
D2 - Large	13	26	78	130	182	39	117	195	273

There are no Media Racks appropriate for the 8" Drawer

Notes: 1. The capacities published here are considered reliable but not guaranteed. Media sizes do vary, check dimensions to be sure.

*UPS at Actual \$
*Flat Rate \$175 MIN

Preconfigured for:



Audio Video Media

4 Standard Shelves per Drawer

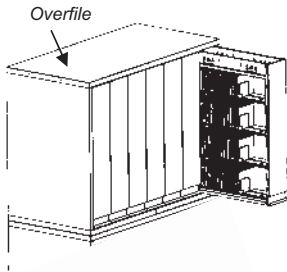

Model	Description	Height	Width	Depth	Weight	*Ship	List
CO-7-4	7 Dwr Overfile /Standard Shelves 4 Shelves / drawer No Backstops	36 1/4	48	24	460	\$125	\$2,817
CO-7-4-B	7 Dwr Overfile /Standard Shelves 4 Shelves / drawer With Backstops	36 1/4	48	24	470	\$125	\$2,942
-L	Optional Turn Key Lock				5		\$73
BE-SL	Slide-N-Lock Bookend	3 1/2	1/8	3 1/2	1	UPS	\$4
ABS-20	Adjustable Backstop	1	20	1	1	UPS	\$4
CO-SH	Standard Shelf	5/8	20 3/8	5 7/8	2	UPS	\$24
CO-SHB	Standard Shelf w/ backstop	5/8	20 3/8	5 7/8	2	UPS	\$28

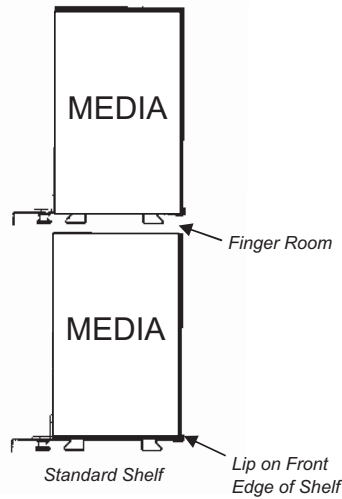
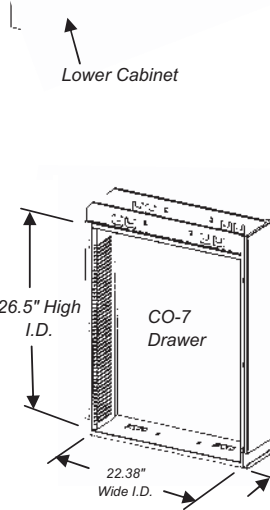

	A/V Capacity	
	Shelves / Dwr.	No Rack / Dwr / Cab
CD / DVD	4	196 / 1,372
Small Beta	3	48 / 336
VHS Case	3	51 / 357

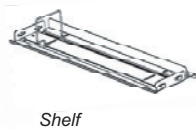

Notes: 1. The capacities published here are considered reliable but not guaranteed. Media sizes do vary, check dimensions to be sure.

*UPS at Actual \$
*Flat Rate \$175 MIN

Preconfigured for:



ProMedia
Cabinets

Classic &
VF Cabinets

Media Shelving
& Slidetrac

Access &
MaxRac

Media
Gemtrac

Slimcase
& Slidetrac

File
Gemtrac

Tambour
Door Kits

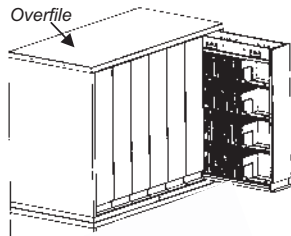

Data Media

5 Recessed Shelves per Drawer

Model	Description	Height	Width	Depth	Weight	*Ship	List
CO-7-5R	7 Dwr Overfile -w/Recessed Shelves 5 Shelves / drawer No Backstops	36 1/4	48	24	480	\$125	\$2,934
CO-7-5R-B	7 Dwr Overfile -w/Recessed Shelves 5 Shelves / drawer With Backstops	36 1/4	48	24	490	\$125	\$3,091
-L	Optional Turn Key Lock				5		\$73
BE-SL	Slide-N-Lock Bookend	3 1/2	1/8	3 1/2	1	UPS	\$4
ABS-20	Adjustable Backstop	1	20	1	1	UPS	\$4
CO-SR	Recessed Shelf	5/8	20 3/8	5 7/8	2	UPS	\$27
CO-SRB	Recessed Shelf w/ backstop	5/8	20 3/8	5 7/8	2	UPS	\$31

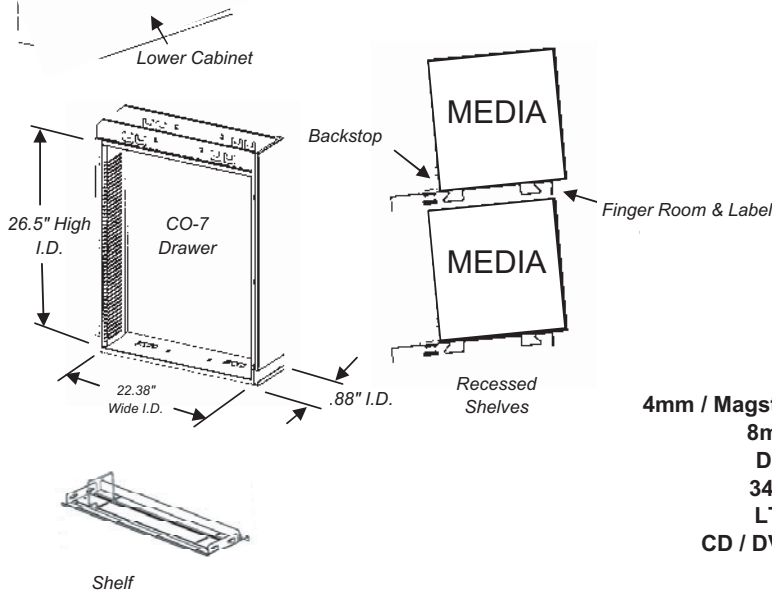

	Data Media Overfile Capacity				
	Shelves With Rack		No Rack		
	/ Dwr.	/ Dwr	/ Cab	/ Dwr	/ Cab
4mm / Magstar	6*	162	1,134	192	1,344
8mm	5	100	700	120	840
DLT	5	70	490	80	560
3480	5	85	595	100	700
LTO	4	64	448	72	504
CD / DVD	4	148	1,036	196	1,372

* 1 Extra Shelf per Drawer Required

Data Media Racks - (For Data Media Overfile)

Note: Use Cabinet with backstops when Media Racks are specified.



Model	Description	Slot	Media	Cap	Height	Width	Depth	Weight	Ship	List
DOMR-14	14 Slot Media Rack	1.29	DLT	14	3.5	20	3	1.5	UPS	\$11
DOMR-16	16 Slot Media Rack	1.10	LTO	16	3.5	20	3	1.5	UPS	\$11
DOMR-17	17 Slot Media Rack	1.02	3480	17	3.5	20	3	1.5	UPS	\$11
DOMR-20	20 Slot Media Rack	0.86	8mm	20	3.5	20	3	1.5	UPS	\$11
DOMR-27	27 Slot Media Rack	0.63	4mm	27	3.5	20	3	1.5	UPS	\$11
DOMR-37	37 Slot Media Rack	0.42	CD	37	3.5	20	3	1.5	UPS	\$11

Notes: 1. The capacities published here are considered reliable but not guaranteed. Media sizes do vary, check dimensions to be sure.

*UPS at Actual \$

*Flat Rate \$175 MIN

Look First at Preconfigured Cabinets, before considering BYO

BYO -Empty Cabinets

Build Your Own - Components

"CS" - Short Cabinets

	Model	Description	I.D.	Height	Width	Depth	Weight	*Ship	List
 <p>27" High 24" Deep</p>	CS30-X	Short, 30"W, No Drawers	24	26 3/4	30	24	55	\$75	\$773
	CS48-X	Short, 48"W, No Drawers	24	26 3/4	48	24	75	\$100	\$851

Cabinet Footprint



30" Wide



48" Wide

All 24" Deep

"CM" - Medium Cabinets

	Model	Description	I.D.	Height	Width	Depth	Weight	*Ship	List
 <p>43" High 24" Deep</p>	CM30-X	Medium, 30"W, No Drawers	40	42 3/4	30	24	75	\$100	\$784
	CM48-X	Medium, 48"W, No Drawers	40	42 3/4	48	24	95	\$125	\$868

Cabinet Footprint



30" Wide



48" Wide

All 24" Deep

"CT" - Tall Cabinets

	Model	Description	I.D.	Height	Width	Depth	Weight	*Ship	List
 <p>59" High 24" Deep</p>	CT30-X	Tall, 30"W, No Drawers	56	58 3/4	30	24	90	\$125	\$801
	CT48-X	Tall, 48"W, No Drawers	56	58 3/4	48	24	110	\$150	\$890

Cabinet Footprint





30" Wide



48" Wide

All 24" Deep

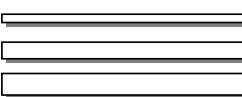
Cabinet Accessories

	-L	Gang Lock					2	INCL.	\$73
	CSP-30-1	1" Filler Panel - 30"W		1	28	2	2	INCL.	\$34
	CSP-30-2	2" Filler Panel - 30"W		2	28	2	3	INCL.	\$34
	CSP-30-3	3" Filler Panel - 30"W		3	28	2	5	INCL.	\$34
	CSP-48-1	1" Filler Panel - 48"W		1	46	2	2	INCL.	\$45
	CSP-48-2	2" Filler Panel - 48"W		2	46	2	5	INCL.	\$45
	CSP-48-3	3" Filler Panel - 48"W		3	46	2	7	INCL.	\$45
	C30-MB	Mobile Caster Base for 30"		5	30	24	34	UPS	\$375
	C48-MB	Mobile Caster Base for 48"		5	48	24	50	UPS	\$425

(Caster Bases for Short & Medium Cabinets Only)

Notes: 1. The capacities published here are considered reliable but not guaranteed. Media sizes do vary, check dimensions to be sure.

*UPS at Actual \$
*Flat Rate \$175 MIN

Look First at Preconfigured Cabinets, before considering BYO

BYO - Empty Drawers

Build Your Own - Components

With No Dividers

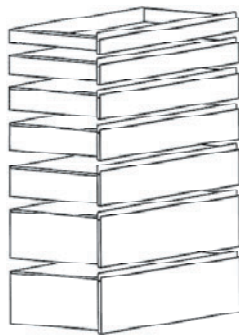

	Model	Description	Height	Width	Depth	Weight	*Ship	List
			Inside Clear					
4"	D30-4X	4" H x 30 Drawer	3.31	26.25	22.13	28	INCL.	\$157
	D48-4X	4" H x 48 Drawer	3.31	44.25	22.13	37	INCL.	\$197
5"	D30-5X	5" H x 30 Drawer	4.31	26.25	22.13	29	INCL.	\$162
	D48-5X	5" H x 48 Drawer	4.31	44.25	22.13	37	INCL.	\$205
6"	D30-6X	6" H x 30 Drawer	5.31	26.25	22.13	30	INCL.	\$169
	D48-6X	6" H x 48 Drawer	5.31	44.25	22.13	39	INCL.	\$212
7"	D30-7X	7" H x 30 Drawer	6.31	26.25	22.13	30	INCL.	\$177
	D48-7X	7" H x 48 Drawer	6.31	44.25	22.13	39	INCL.	\$218
8"	D30-8X	8" H x 30 Drawer	7.31	26.25	22.13	30	INCL.	\$184
	D48-8X	8" H x 48 Drawer	7.31	44.25	22.13	41	INCL.	\$226
11"	D30-11-STS	11" H x 30 File Drawer	10.31	26.25	22.13	29	INCL.	\$205
	D48-11-STS	11" H x 48 File Drawer	10.31	44.25	22.13	45	INCL.	\$248
11"	D30-11-FTB	11" H x 30 File Drawer	10.31	26.25	22.13	32	INCL.	\$211
	D48-11-FTB	11" H x 48 File Drawer	10.31	44.25	22.13	54	INCL.	\$259
12"	D30-12-STS	12" H x 30 File Drawer	11.31	26.25	22.13	31	INCL.	\$212
	D48-12-STS	12" H x 48 File Drawer	11.31	44.25	22.13	47	INCL.	\$254
12"	D30-12-FTB	12" H x 30 File Drawer	11.31	26.25	22.13	34	INCL.	\$217
	D48-12-FTB	12" H x 48 File Drawer	11.31	44.25	22.13	56	INCL.	\$265

Note: The sum of all drawers must fill the cabinet I.D. opening. See also filler panels on previous page.

Bookend Supports



Model	Description	Slot	Min Dwr	Cap	Weight	Ship	List
SLD-22	Slide-N-Lock Drawer Divider	2	3/16	22	0.3		\$3
BE-2X2	2" Bookend	2 1/2	1 3/4	2 1/4	0.2	UPS	\$8
BE-3X3	3" Bookend	2 3/4	2 3/4	2 1/4	0.2	UPS	\$8
BE-4X4	4" Bookend	3 3/4	3 3/4	2 1/4	0.3	UPS	\$8
BE-5X5	5" Bookend	4 3/4	4 3/4	2 1/4	0.6	UPS	\$8
BE-6X6	6" Bookend	5 3/4	5 3/4	2 1/4	0.7	UPS	\$8
BE-CD	Hinged Bookend for CD's	3 3/4	4	2 1/4	1	UPS	\$11

Data Media Racks

Provides Dedicated Slots - Order Separate with Appropriate Empty Drawer



Model	Description	Slot	Min Dwr	Cap	Weight	Ship	List
DR30-4mm	4mm Rack for 30" Drawer	.63 x 3.20	4	180	7	UPS	\$45
DR48-4mm	4mm Rack for 48" Drawer	.63 x 3.20	4	330	7	UPS	\$90
DR30-8mm	8mm Rack for 30" Drawer	.85 x 4.18	4	115	4	UPS	\$45
DR48-8mm	8mm Rack for 48" Drawer	.85 x 4.18	4	207	6	UPS	\$90
DR30-3480	3480 Rack for 30" Drawer	1.01 x 4.32	6	95	4	UPS	\$45
DR48-3480	3480 Rack for 48" Drawer	1.01 x 4.32	6	175	7	UPS	\$90
DR30-DLT	DLT Rack for 30" Drawer	1.28 x 4.50	6	75	3	UPS	\$45
DR48-DLT	DLT Rack for 48" Drawer	1.28 x 4.50	6	120	5	UPS	\$90
DR30-CD	CD Rack for 30" Drawer	.42 x 4.95	7	164	4	UPS	\$45
DR48-CD	CD Rack for 48" Drawer	.42 x 4.95	7	328	7	UPS	\$90

*UPS at Actual \$

Notes: 1. The capacities published here are considered reliable but not guaranteed. Media sizes do vary, check dimensions to be sure.

*Flat Rate \$175 MIN

ProMedia Cabinets
 Classic & VF Cabinets
 Media Shelving & Slidetrac
 Access & MaxRac
 Media Gemtrac
 Slimcase & Slidetrac
 File Gemtrac
 Tambour Door Kits

With ProMedia, you can specify the drawer combination to meet your exact needs

1 Select Drawers and sketch-in location

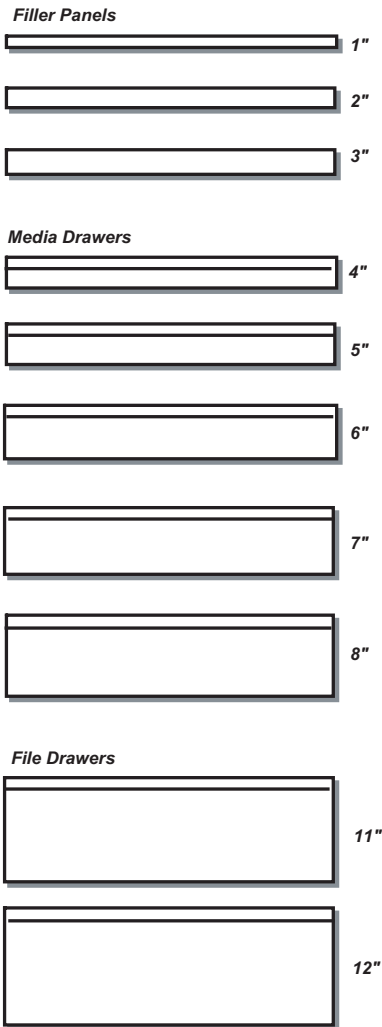

2 Select Height

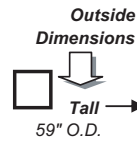

3 Lock?
 YES
 NO

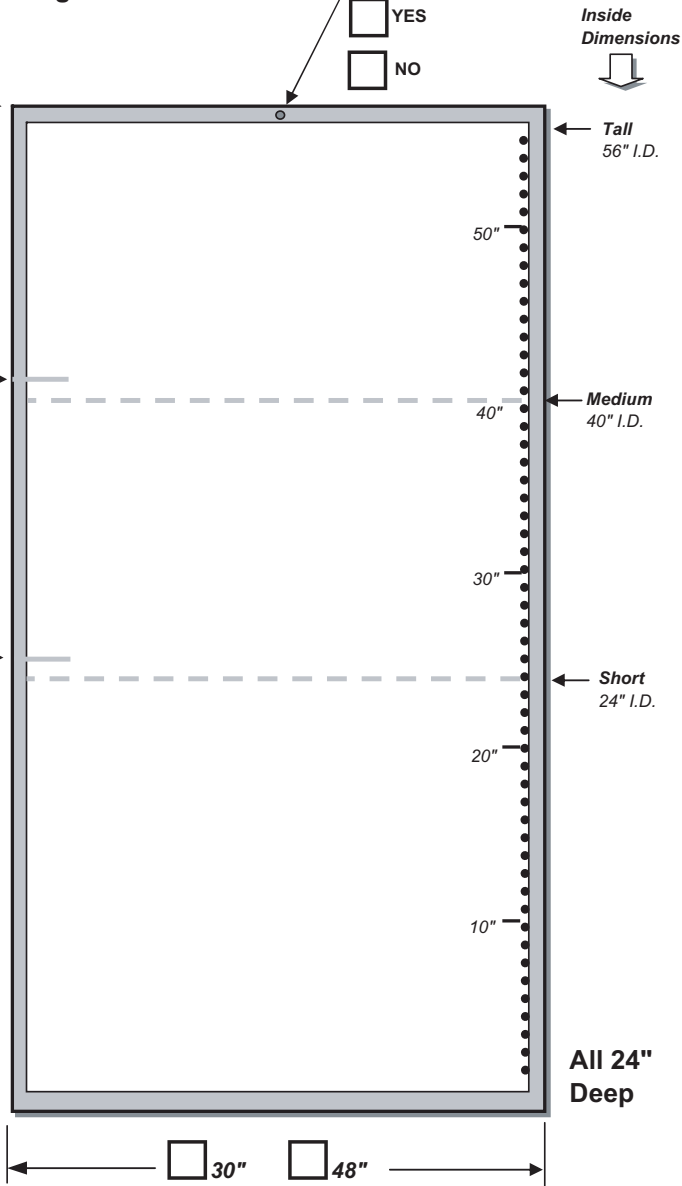

4 Select Width

5 Color: _____

6 Accessories:

QTY	P/N
_____	_____
_____	_____
_____	_____
_____	_____

7 Quantity: _____
Units Exactly Like This

Send in a marked copy of this worksheet with your order and we will custom build a unit to your exact specifications.

ProMedia Cabinets

Classic & VF Cabinets

Media Shelving & Slidetrac

Access & MaxRac

Media Gemtrac

Slimecase & Slidetrac

File Gemtrac

Tambour Door Kits

With ProMedia, you can specify the drawer combination to meet your exact needs

ProMedia Cabinets

Classic & VF Cabinets

Media Shelving & Slidetrac

Axess & MaxRac

Media Gemtrac

Slimcase & Slidetrac

File Gemtrac

Tambour Door Kits

1 Select Drawers and sketch-in location

- Filler Panels**
- 1"
- 2"
- 3"
- Media Drawers**
- 4" **Medium** 43" O.D.
- 5"
- 6"
- 7"
- 8"
- File Drawers**
- 11"
- 12"

2 Select Height

- Outside Dimensions**
- Tall 59" O.D.
- Medium 43" O.D.
- Short 27" O.D.

3 Lock?

- YES
- NO

Inside Dimensions

EXAMPLE

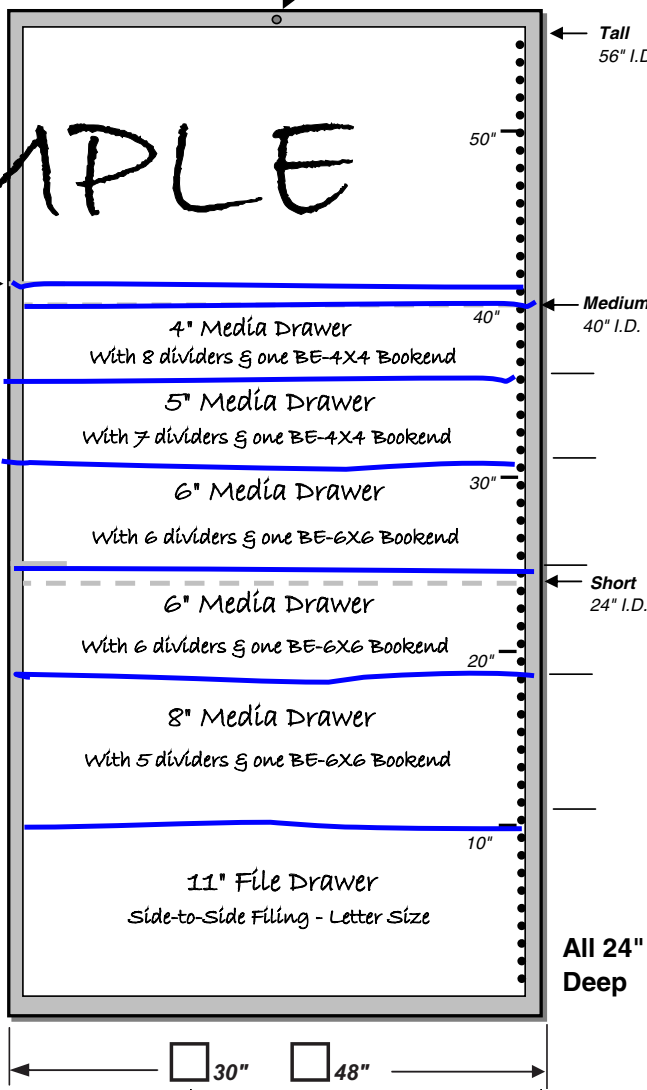

4 Select Width

- 30"
- 48"

5 Color: Black

6 Accessories:

QTY	Part Number
26	SLD-22 Dividers
2	BE-4X4
3	BE-6X6

7 Quantity: 3
Units Exactly Like This

Send in a marked copy of this worksheet with your order and we will custom build a unit to your exact specifications.